

Wagon kryty serii Kddx typu 68W

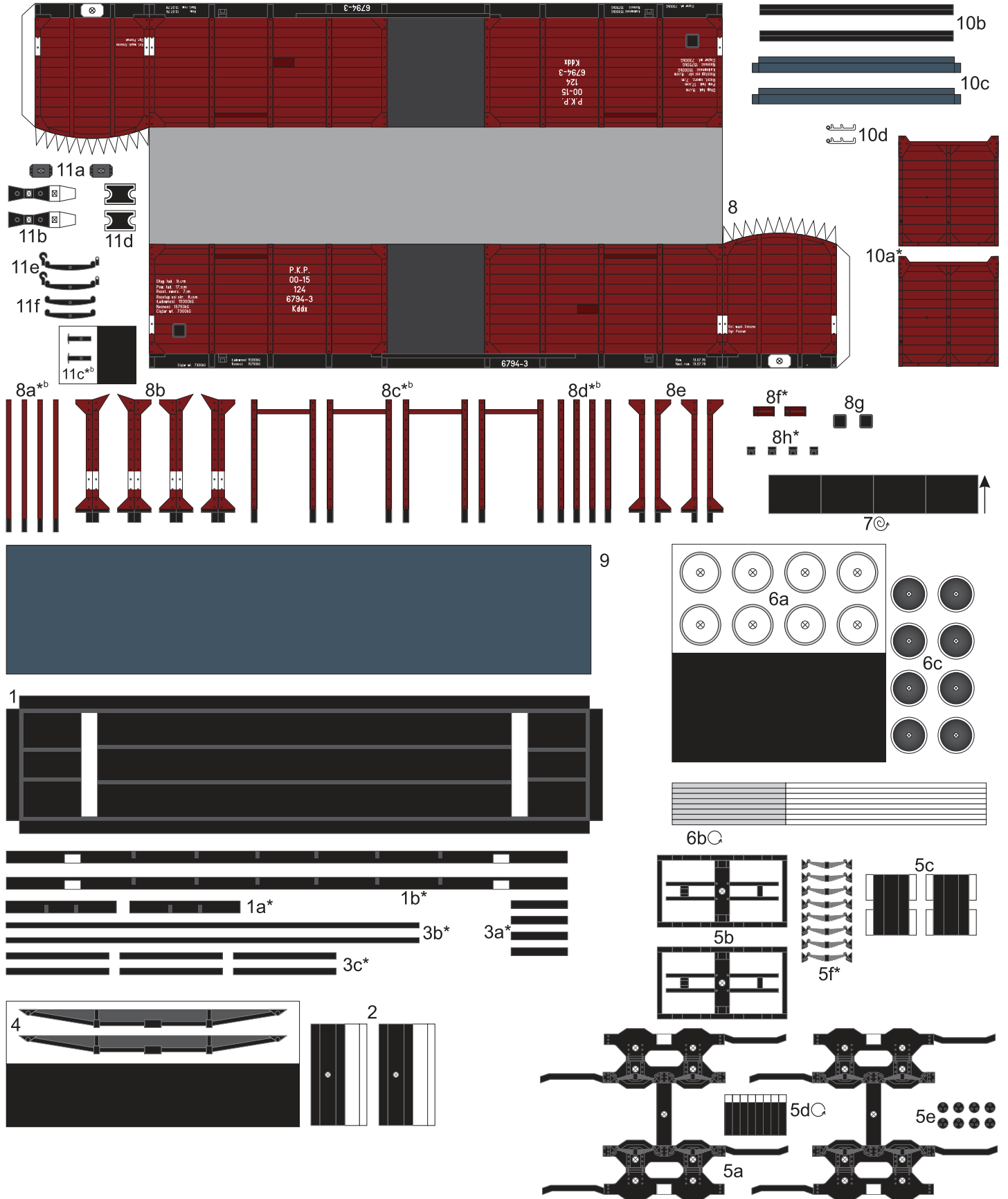

Części uproszczone

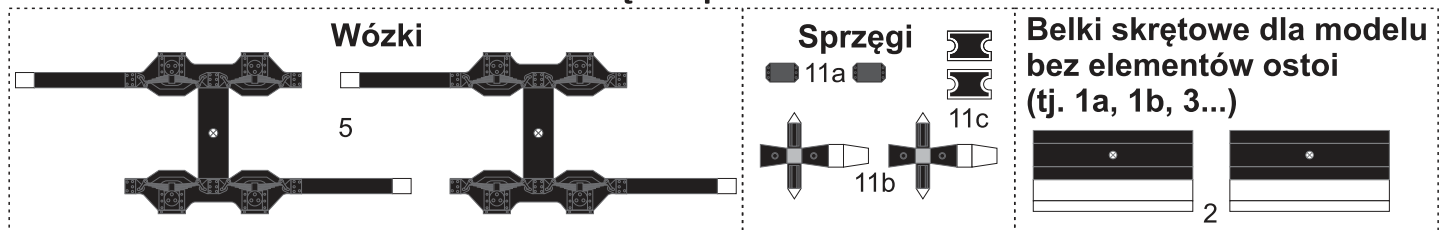

Wnętrze (dla modelu z otwartymi drzwiami)

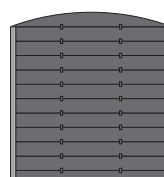
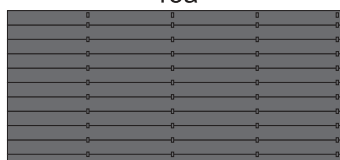
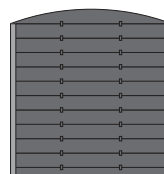
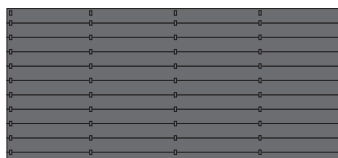
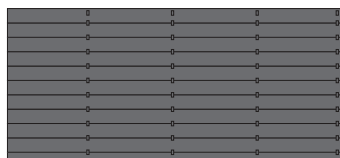
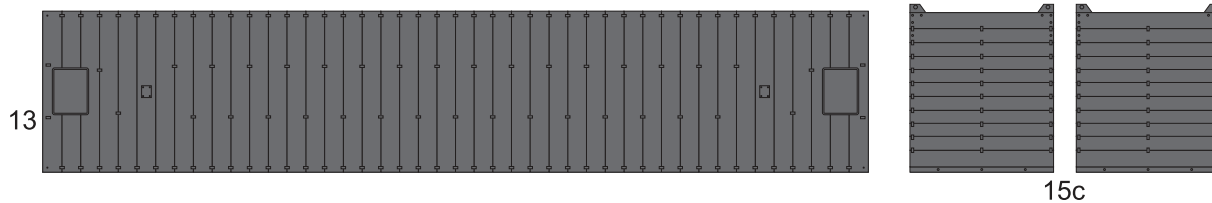
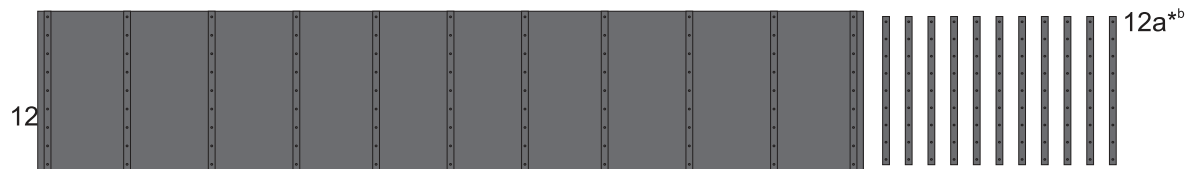

Wręgi (dla modelu z zamkniętymi drzwiami)

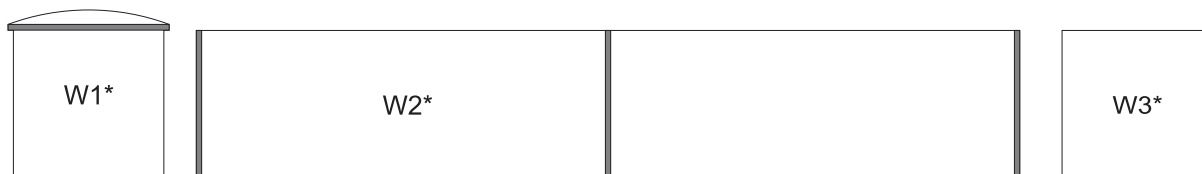
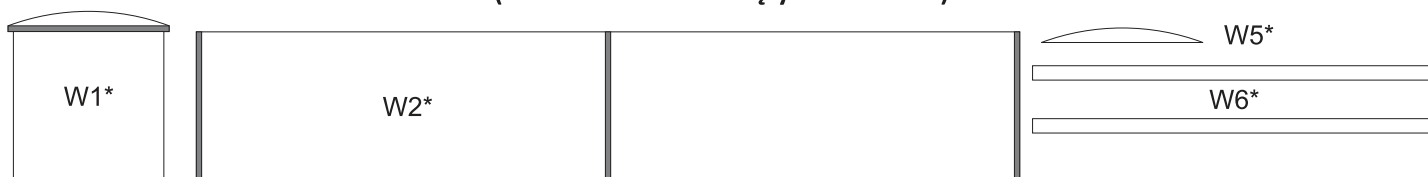

Elementy do wykonania z drutu

- I - Ø1,0mm - 4szt.
- II - Ø1,0mm - 2szt.
- III - Ø0,25mm - 8szt.

Instrukcja

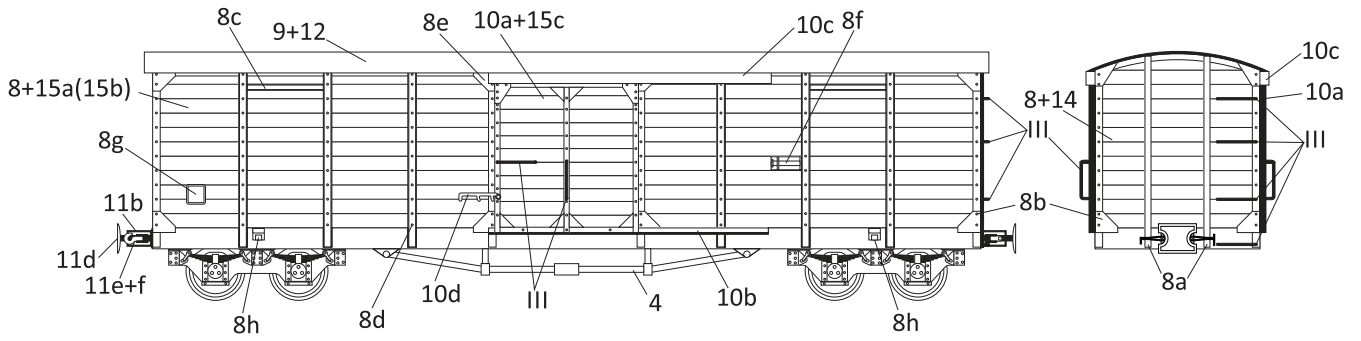

Wózki

(skala 1,5:1)

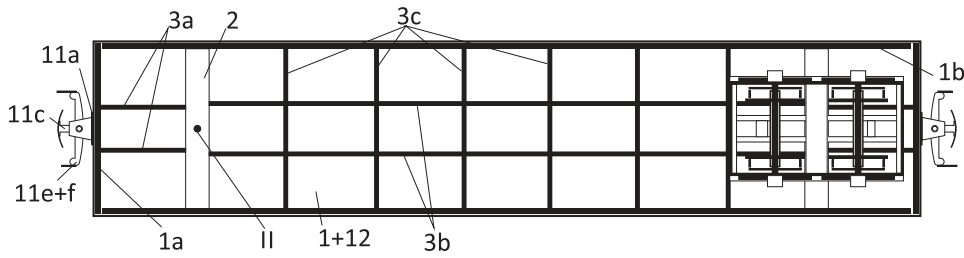
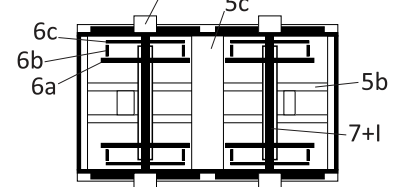
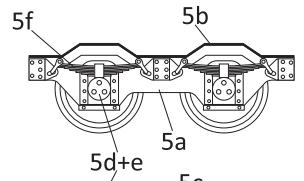

Wnętrze

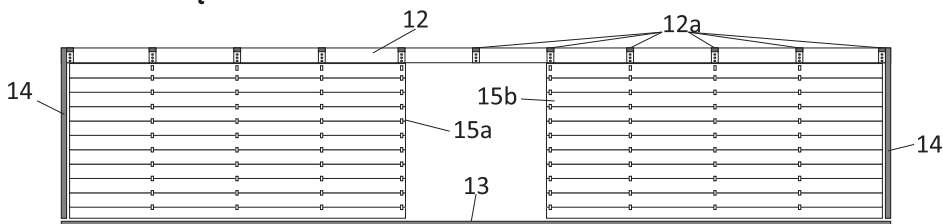

Schemat montażu wręgów

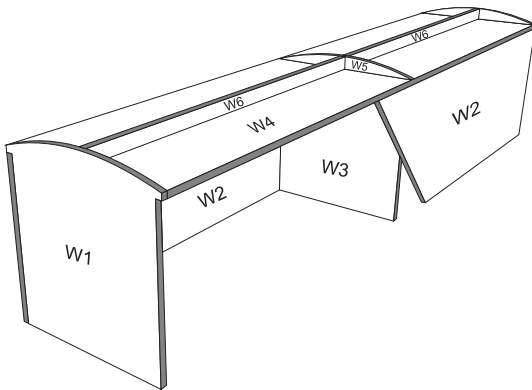

Objaśnienia

*^b - podkleić brystolem

* - podkleić kartonem 0,5mm

⊖ - zwinąć w walec (widoczny tylko fragment zabarwiony)

⊖ - zwinąć ciasno

→ - kierunek zwijania

↶^{11b} - część po wewnętrznej stronie